

CD Soundmachine

AZ2537

User Manual
Manuel d'utilisation
Manual del usuario

PHILIPS CONSUMER ELECTRONICS NORTH AMERICA

Knoxville, Tennessee 37914-1810, U.S.A.

Meet Philips at the Internet
<http://www.philips.com>



Need help? Call us!

Philips representatives are ready to help you with any questions about your new product.

CALL US BEFORE YOU CONSIDER RETURNING THE PRODUCT!

1-800-531-0039

or visit us on the web at www.philips.com

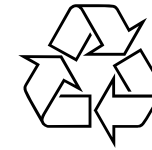

AZ 2537



PHILIPS



Return your Product Registration Card today to get the very most from your purchase.

Registering your model with PHILIPS makes you eligible for all of the valuable benefits listed below, so don't miss out. Complete and return your Product Registration Card at once to ensure:

*Proof of Purchase

Returning the enclosed card guarantees that your date of purchase will be on file, so no additional paperwork will be required from you to obtain warranty service.

*Product Safety Notification

By registering your product, you'll receive notification - directly from the manufacturer - in the rare case of a product recall or safety defect.

*Additional Benefits of Product Ownership

Registering your product guarantees that you'll receive all of the privileges to which you're entitled, including special money-saving offers.

Know these safety symbols



 This “bolt of lightning” indicates uninsulated material within your unit may cause an electrical shock. For the safety of everyone in your household, please do not remove product covering.

 The “exclamation point” calls attention to features for which you should read the enclosed literature closely to prevent operating and maintenance problems.

For Customer Use

Enter below the Serial No. which is located on the rear of the cabinet. Retain this information for future reference.

Model No. _____

Serial No. _____

WARNING: To reduce the risk of fire or electric shock, this apparatus should not be exposed to rain or moisture, and objects filled with liquids, such as vases, should not be placed on this apparatus.

CAUTION: To prevent electric shock, match wide blade of plug to wide slot, fully insert.

ATTENTION: Pour éviter les choc électriques, introduire la lame la plus large de la fiche dans la borne correspondante de la prise et pousser iusau'au fond.

IMPORTANT SAFETY INSTRUCTIONS

1. Read these instructions.
2. Keep these instructions.
3. Heed all warnings.
4. Follow all instructions.
5. Do not use this apparatus near water.
6. Clean only with dry cloth.
7. Do not block any ventilation openings. Install in accordance with the manufacturer's instructions.
8. Do not install near any heat sources such as radiators, heat registers, stoves, or other apparatus (including amplifiers) that produce heat.
9. Do not defeat the safety purpose of the polarized or grounding-type plug. A polarized plug has two blades with one wider than the other. A grounding type plug has two blades and a third grounding prong. The wide blade or the third prong are provided for your safety. If the provided plug does not fit into your outlet, consult an electrician for replacement of the obsolete outlet.
10. Protect the power cord from being walked on or pinched, particularly at plugs, convenience receptacles, and the point where they exit from the apparatus.
11. Only use attachments/accessories specified by the manufacturer.
12.  Use only with the cart, stand, tripod, bracket, or table specified by the manufacturer or sold with the apparatus. When a cart is used, use caution when moving the cart/apparatus combination to avoid injury from tip-over.
13. Unplug this apparatus during lightning storms or when unused for long periods of time.
14. Refer all servicing to qualified service personnel. Servicing is required when the apparatus has been damaged in any way, such as power-supply cord or plug is damaged, liquid has been spilled or objects have fallen into the apparatus, the apparatus has been exposed to rain or moisture, does not operate normally, or has been dropped.
15. Battery usage **CAUTION** – To prevent battery leakage which may result in bodily injury, property damage, or damage to the unit:
 - Install **all** batteries correctly, + and - as marked on the unit.
 - Do not mix batteries (**old** and **new** or **carbon** and **alkaline**, etc.).
 - Remove batteries when the unit is not used for a long time.
16. Apparatus shall not be exposed to dripping or splashing.
17. Do not place any sources of danger on the apparatus (e.g. liquid filled objects, lighted candles).
18. This product may contain lead and mercury. Disposal of these materials may be regulated due to environmental considerations. **For disposal or recycling information, please contact your local authorities or the Electronic Industries Alliance : www.eiae.org.**

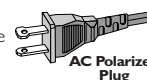

Class II equipment symbol



This symbol indicates that the unit has a double insulation system.

EL 6475-E005: 04/01

1

HEAVY !
Take care of your CD Soundmachine.
Grip both handles when you carry or lift the set.

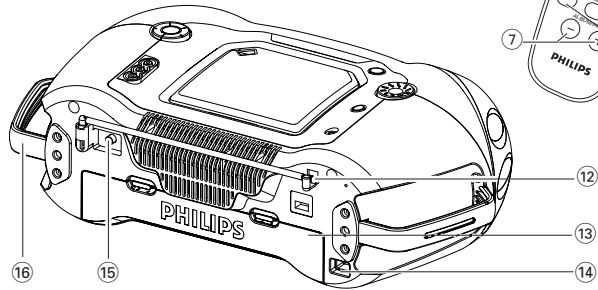
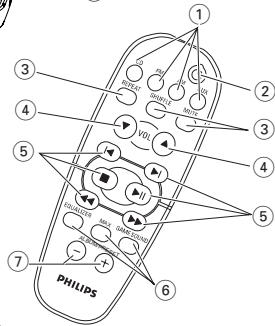
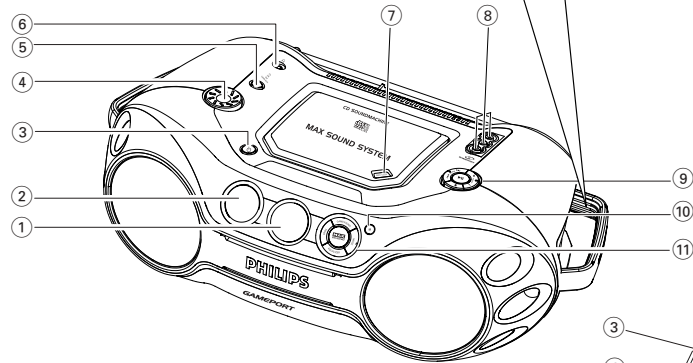

2

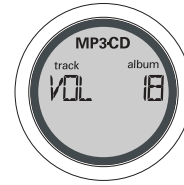

6

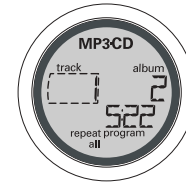

3

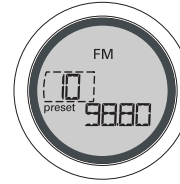

7

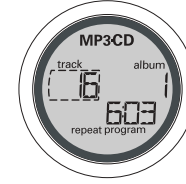

4

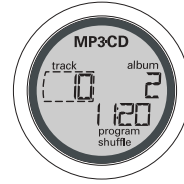

8



5

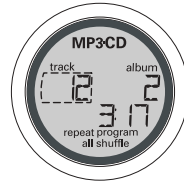

English

SUPPLIED ACCESSORIES

- remote control
- video cable
- AC power cord
- Stand

TOP AND FRONT PANEL (See 1)

- LCD Display** – shows the status of the set
- [dB]**: – display to indicate bass power.
- STANDBY ON** – switches the set on/ off.
- VOLUME** – adjusts volume level or equalizer level
- SOURCE** – selects sound source for functions: **CD/ FM / AM / GAME AUX**.
- 3.5 mm stereo headphone jack.
Note: The speakers will be muted when headphones are connected to the set.
- OPEN•CLOSE** – press to open/ close CD door
- AUDIO IN (LEFT / RIGHT)** – keeps video plug in place.
VIDEO IN – keeps video plug in place
- ALBUM/PRESET** ,
MP3-CD only : – selects previous/next albums.;
FM/AM : selects previous/next preset stations.
SEARCH ,
MP3-CD/audio-CD: – skips and searches tracks backward/forward.
FM/AM : - searches radio stations.
 – starts or pauses CD playback
 – stop CD playback;
– erases a CD program

CONTROL

- IR SENSOR** – infrared sensor for remote control
- GAMESOUND** – select sound effects: **BLAST/ PUNCH/ SPEED/ NORMAL** in **GAME AUX** mode
EQUALIZER – selects bass, mid and treble frequencies.
PROG
MP3-CD/audio-CD : – programs tracks and reviews the programmed songs;
FM / AM : – programs preset radio stations.
MODE – selects different CD play modes: e.g. REPEAT or SHUFFLE order.
MAX SOUND – activates or deactivate the optimal mix of various sound features

BACK PANEL (See 1)

- Telescopic antenna** – improves FM reception
- Battery compartment** – for 8 batteries, type R-20, UM-1 or D-cells
- AC MAINS** – inlet for power cord
- VIDEO OUT** – connects to the **VIDEO IN** jack on a TV or VCR for viewing or recording.
- HANDLE**

Optional stand for vertical mounting (See C)

With the optional stand, you are allowed to mount the set vertically. It helps you arrange your available space more flexibly.

- Put the stand on a horizontal, vibration-free and stable surface.
- Take the set by handle, with the AC MAINS at the lower side.
- Align the handle on the other side with the space in the middle of the stand.
- Mount the set upright and firmly onto the stand.
- Fasten the bolt on the stand by pressing it and by rotating it clockwise.

CONTROL

REMOTE CONTROL (See 1)

- CD** – selects CD sound source
FM / AM – selects tuner source / wavebands
AUX – selects **GAME AUX**
- switches the set to standby / on if set operating on AC power. (Switches set off only if battery powered)
- REPEAT** – selects repeat modes in CD source;
SHUFFLE – selects shuffle modes in CD source;
MUTE – interrupts/ resumes sound
- VOL** , – adjusts volume or equalizer level.
- , – selects previous/ next tracks in a MP3-CD/audio CD;
 – stops CD playback;
– erases a CD program.
 – starts or pauses CD playback
, – searches backwards/ forwards within a MP3-CD/audio CD track.
– searches radio stations.
- EQUALIZER** – selects bass, mid and treble frequencies
MAX – selects special bass enhancement on/ off
GAMESOUND – selects sound effects: **BLAST/ PUNCH/ SPEED/ NORMAL** in game mode
- ALBUM/PRESET** ,
MP3-CD only : – selects previous/ next albums.
FM/AM : – selects previous/next preset station.

POWER SUPPLY

Whenever convenient, use the power supply to conserve battery life. Make sure you remove the power cord from the set and wall jack before inserting batteries.

BATTERIES

Using batteries (not included)

Main set (See A)

- Insert 8 batteries, type **R-20, UM-1** or **D-cells**, (preferably alkaline) with the correct polarity.

POWER SUPPLY

Remote control (See B)

- Insert 2 batteries, type **AAA, R03** or **UM4** (preferably alkaline).

Helpful Hints:

- Incorrect use of batteries can cause electrolyte leakage and will corrode the compartment or cause the batteries to burst.*
- Do not mix battery types: e.g. alkaline with carbon zinc. Only use batteries of the same type for the set.*
- When inserting new batteries, do not try to mix old batteries with the new ones.*
- Batteries contain chemical substances, so they should be disposed of properly.**

USING AC POWER

- Check if the AC power supply, as shown on the **type plate located on the bottom of the set**, corresponds to your local power supply. If it does not, consult your dealer or service center.
- If your set is equipped with a voltage selector, adjust the selector so that it matches with the local power supply.
- Connect the power cord to the wall jack and the set is now ready for use.

Helpful Hints:

- To disconnect the power supply, unplug the set from the wall jack.*
- Disconnect the power supply to protect your set during heavy thunderstorms.*

POWER-SAVING AUTOMATIC STANDBY

As a power-saving feature, the system automatically switches to standby 15 minutes after CD has reached the end and no control is operated.

The type plate is located on the bottom of the set.

BASIC FUNCTIONS

SWITCHING ON AND OFF

1. Press **STANDBY ON** \odot on the set to switch on (or press **STANDBY ON** on the remote control to switch the set to standby mode).
2. Press **SOURCE** once or more to select your desired function: **CD, FM, AM, GAME AUX**.
3. Press **STANDBY ON** \odot on the set to switch off. (or press **STANDBY ON** on the remote control to switch the set to standby mode)

Helpful Hints:

- The tone, sound settings, tuner presets and the volume level (up to a maximum volume level of VOL 20) will be retained in the set's memory.

ADJUSTING VOLUME AND SOUND

- Adjust the volume with the **VOLUME** control.
 - Display shows the volume level VOL and a number from 0-32. (See [2](#))

MAX SOUND

To enhance the bass response: press **MAX SOUND** once or more to switch on / off.

- **MAX SOUND**-key backlight lights up when **MAX SOUND** is turned on.

Helpful Hints:

- **MAX SOUND** can be used when you play FM, AM, CD and GAME AUX source.
- Some discs might be recorded in high modulation, which causes a distortion at high volume. If this occurs, deactivate **MAX SOUND** or reduce the volume.

EQUALIZER

1. To adjust the bass, mid and treble frequencies press **EQUALIZER** once or more;
2. Rotate **VOLUME** within 3 seconds to adjust each level.
 - Display briefly shows **BASS** , **MID** , or **HIGH** level (**-5 to +5**) or **VOL** .

Helpful Hints:

- **EQUALIZER** can be used during FM, AM, CD and GAME AUX source.
- To prevent sound interference the bass control options operate exclusively. You cannot combine the bass from **EQUALIZER** with **MAX SOUND** .

GAMESOUND

To adjust the game sound, press **GAMESOUND** once or more to select your option.

- Display briefly shows **BLAST** , **PUNCH** , **SPEED** or **NORMAL** .

Helpful Hints:

- **GAMESOUND** is only available when you play in **GAME AUX** source.

How to MUTE the sound

1. Press **MUTE** on the remote control to interrupt sound reproduction instantly.
 - Playback continues without sound and the display flashes **MUTE** .
2. To reactivate sound reproduction you can:
 - press **MUTE** again;
 - adjust the volume controls;
 - change to another source.

DIGITAL TUNER

Tuning to stations (See [3](#))

1. Press **STANDBY ON** \odot to on, then press **SOURCE** once or more to select **FM/AM** (or press **FM/AM** on the remote control).
 - Display: shows **TUNER** briefly followed by waveband, frequency, and preset station number if already stored.
 2. **Tuning to stations:** you can tune to your stations manually or by automatic search tuning: Press down on \lll or \ggg (\lll or \ggg on the remote control) and release button when the frequency in the display starts running.
 - The radio automatically tunes to a station of sufficient reception. Display shows **SEARCH** during automatic tuning.
 3. Repeat step 2 if necessary until you find the desired station.
- To tune to a weak station, press \lll or \ggg briefly and repeatedly until you have found optimal reception.

Helpful Hints:

To improve radio reception:

- For **FM**, extend, incline and turn the telescopic antenna. Reduce its length if the signal is too strong.
- For **AM**, the set uses a built-in antenna. Direct this antenna by turning the whole set.

Programming tuner stations:

You can store up to a total of 30 radio stations in the memory, manually or automatically (Autostore).

Autostore

Automatic programming will start from preset 1 or a chosen preset number. The set will only program stations which are not in the memory already.

1. Press **ALBUM/PRESET -/+** once or more to select the preset number where programming should start.

Helpful Hints:

- If no tuner preset number is selected, default is preset 1 and all your presets will be erased.

2. Press **PROG** for 4 seconds or more to activate auto store programming.

- Display: **AUTOSTORE** is shown and available stations are programmed in order of waveband **FM**, followed by **AM** ,

3. The first preset station will then be played after all stations are stored automatically.

Manual programming

1. Tune to your desired station (see **Tuning to stations**).

2. Press **PROG** to activate programming.
 - Display: **Program** flashes.

3. Press **ALBUM/PRESET -/+** once or more to allocate a number from 1 to 30 to this stations.

4. Press **PROG** again to confirm.
 - Display: shows the preset number, waveband and the frequency of the preset station.

The set complies with the FCC-Rules, Part 15 and with 21 CFR 1040.10.

Operation is subject to the following two conditions:

1. **This device may not cause harmful interference, and**
2. **This device must accept any interference received, including interference that may cause undesired operation.**

MP3-CD/CD PLAYER

About MP3

The music compression technology MP3 (MPEG Audio Layer 3) reduces the digital data of an audio CD significantly while maintaining CD-like sound quality.

How to get music files

Either download legal music files from the internet to your computer hard disc or create them from your own audio CDs. For this, insert an audio CD into your computer's CD-ROM drive and convert the music using an appropriate encoder software. To achieve a good sound quality, a bit rate of 128 kbps or higher is recommended for MP3 music files.

How to make a CD-ROM with MP3 files

Use your computer's CD burner to record ("burn") the music files from your hard disc on a CD-ROM.

✔ Helpful Hints:

- For details on using MP3 encoder and writing software, please refer to the operating instructions of the software.
- Make sure that the file names of the MP3 files end with **.mp3**.
- Total number of music files and albums: around 350 (with a typical file name length of 20 characters)
- The number of music files that can be played depends on the length of the file names. With short file names more files will be supported.

IMPORTANT !

This set does not play/support the following file formats:

- Word documents **.doc** or MP3 files with extension **.dlf**.
- **Playlist files** (e.g. **.m3u**, **.pls** of WMA, AAC, Winamp, Sonic, RealJunkbox, Ms Mediaplayer 7.0, MusicMatch).
- Recordings created on **PacketWriting** and **Package Writing**.

Playing a CD

This CD player plays Audio Discs including CD-R(W) and MP3 CD-ROMs. Do not try to play a CD-I, CDV, VCD, DVD or computer CD.

1. Press **STANDBY ON** \odot once or more to on.
2. Select **CD SOURCE**.
3. Press **OPEN•CLOSE** to open the CD door.
→ **CD OPEN** is displayed when the CD door is open.
4. Insert a CD with the printed side facing up and press down on **OPEN•CLOSE** to close the CD door.
→ Display shows **READY** and later, the total track/album number and total playback time.

5. Press **▶▶** to start playback.

→ Display shows : current track/album number and elapsed playing time

✔ Helpful Hints:

- Depending on the track type, CD or MP3 will appear on the display during playback.
- Album number is only shown for MP3 files.

To pause playback

- Press **▶▶**.
→ the elapsed playing time flashes.
- Press **▶▶** again to resume play.

To stop playback

- Press \blacksquare .
→ Display shows :the total track/album number and total playback time

✔ Helpful Hints:

- The MP3-CD/audio CD playback will also stop when:
- the CD door is opened
 - the CD has reached the end
 - you select an other sound source.

Selecting a different track

During playback

- Press **SEARCH** \lll or \ggg (\lll or \ggg on the remote control) once or repeatedly until the desired track number appears in the display.

During stop or pause

- Press **▶▶** to start playback after your desired track is selected.

✔ Helpful Hints:

- To find a MP3 track, you can first press **ALBUM/PRESET** $-/+$ to select the desired album.

Searching for a passage within a track

1. During playback, press and hold **SEARCH** \lll or \ggg (\lll or \ggg on the remote control).
2. When you recognize the passage you want, release \lll or \ggg (\lll or \ggg on the remote control).
→ Normal playback continues from this position.

MP3-CD/CD PLAYER

Different playing modes: SHUFFLE and REPEAT (See $\boxed{4}$ - $\boxed{7}$)

You can select and change the various play modes before or during playback. The play modes can also be combined with PROGRAM.

shuffle - tracks of the entire CD/ program are played in random order

repeat all shuffle - repeats the entire CD/ program continuously in random order

repeat all - repeats the entire CD/ program

repeat - plays the current track continuously

To select a playing mode

- Press **MODE** once or more.(**SHUFFLE** / **REPEAT** on the remote control).
- Press **▶▶** to start playback if in the stop position.

To return to normal playback

- press **MODE** repeatedly until the various modes are no longer displayed.

✔ Helpful Hints:

- When you press \blacksquare , the selected playing mode is also cancelled.

Programming track numbers

You can store up to 20 tracks to play in a program. A single track may be stored more than once in the program.

1. Press \blacksquare to stop playback

2. Press **SEARCH** \lll or \ggg on the set to select your desired track number (\lll , \ggg on the remote control)

✔ Helpful Hints:

- To find a MP3 track, you can press **ALBUM/PRESET** $-/+$ to select the desired album.

3. Press **PROG**

→ Display shows: **PROGRAM** and the selected track number. **PROG** and the number of tracks stored appear briefly.

4. Repeat steps **2-3** to select and store all desired tracks.

5. To start playback of your disc program, press **▶▶**.

✔ Helpful Hints:

- During normal playback, you can press **PROG** to add a current track to your program list.
- **SELECT TRACK** appears if you press **PROG** and there is no track selected.
- **FULL** appears if you try to store more than 20 tracks.

Reviewing the program

- In the stop position, press and hold down **PROG** for a while until the display shows all your stored track numbers in sequence.

✔ Helpful Hints:

- Display shows : **NO PROG** if there is no track programmed.

Clearing a program

You can erase the contents of the memory by:

- Press \blacksquare :
 - Once, if in the stop position;
 - Twice, during playback.
- Press **STANDBY ON**;
- Select another sound source;
- open the CD door
→ **CLEAR** displayed briefly, and **Program** disappears.

GAMESOUND

PLAYING WITH GAMESOUND (See 8):

1. Press **SOURCE** once or more on the set to select the **GAME AUX** function (**AUX** on the remote control)
→ Display scrolls : **GAME PORT**
2. Connect your console to the cinches on the front of the set **AUDIO IN (LEFT / RIGHT)** and **VIDEO IN**.
3. Press **GAMESOUND** once or more to select your game sound option.
→ Display briefly shows **BLAST** , **PUNCH** , **SPEED** or **NORMAL**.

Connecting other equipment to your system

Use the supplied video cable to connect the **VIDEO OUT** terminal on the back of the set to **VIDEO IN** on a TV or VCR for viewing or recording.

MAINTENANCE & SAFETY

MAINTENANCE & SAFETY (See 9)

CD player and disc handling

- If the CD player cannot read CDs correctly, use a cleaning CD to clean the lens before taking the set to repair.
- The lens of the CD player should never be touched!
- Sudden changes in the surrounding temperature can cause condensation on the lens of your CD player. Playing a CD is then not possible. Do not attempt to clean the lens but leave the set in a warm environment until the moisture evaporates.
- Always close the CD door to avoid dust on the lens.
- To clean the CD, wipe in a straight line from the centre towards the edge using a soft, lint-free cloth. Do not use cleaning agents as they may damage the disc.
- Never write on a CD or attach any stickers to it.

MAINTENANCE & SAFETY

Safety Information

- Don't expose the set, batteries, or CDs to humidity, rain, sand or excessive heat.
- To clean the set with a dry cloth. Don't use any cleaning agents containing alcohol, ammonia, benzene or abrasives as these may harm the set.
- Place the set on a hard and flat surface so that the system does not tilt. Make sure there is good ventilation to prevent the set overheating.
- The mechanical parts of the set contain self-lubricating bearings and must not be oiled or lubricated.
- Apparatus shall not be exposed to dripping or splashing.
- Do not place any sources of danger on the apparatus (e.g. liquid filled objects, lighted candles)

Canada

English

This digital apparatus does not exceed the Class B limits for radio noise emissions from digital apparatus as set out in the Radio Interference Regulations of the Canadian Department of Communications.

Français

Cet appareil numérique n'émet pas de bruits radioélectriques dépassant les limites applicables aux appareils numériques de Classe B prescrites dans le Règlement sur le Brouillage Radioélectrique édicté par le Ministère des Communications du Canada.

CAUTION

Use of controls or adjustments or performance of procedures other than herein may result in hazardous radiation exposure or other unsafe operation.

Environmental information

We have done our best to reduce the packaging and make it easy to separate into 3 materials: cardboard, expandable polystyrene, polyethylene.

Your set consists of materials which can be recycled if disassembled by a specialized company. Please observe the local regulations regarding the disposal of packaging, exhausted batteries and old equipment.

TROUBLESHOOTING

If a fault occurs, first check the points listed below before taking the set for repair. If you are unable to remedy a problem by following these hints, consult your dealer or service center.

WARNING: *Do not open the set as there is a risk of electric shock! Under no circumstances should you try to repair the set yourself, as this will invalidate the warranty.*

No sound /power

- Volume not adjusted
- Adjust the VOLUME
- Power Cord not securely connected
- Connect the AC power cord properly
- Batteries flat / incorrectly inserted
- Insert (fresh) batteries correctly
- Headphones connected to the set
- Disconnect headphones
- Electrostatic discharge/interference
- Unplug the set. If batteries inserted, remove batteries from the battery compartment. Press and hold **STANDBY ON** \odot for 10 seconds, then re-plug / replace battery supply, and try activating the set again.
- CD contains non-audio files
- Press **SEARCH** \lll or \ggg once or more to skip to a CD audio track, instead of the data file

Poor sound quality in GAME AUX mode

- Adjust the volume on the set or on your game console

Severe radio hum or noise

- Electrical interference: set too close to TV, VCR or computer
- Move the set to increase the distance

Remote control does not function properly

- Batteries flat/ incorrectly inserted
- Insert (fresh) batteries correctly
- Distance/ angle between the set too large
- Reduce the distance/ angle

Poor radio reception

- Weak radio signal
- FM / AM: Adjust the FM / AM telescopic aerial

NF DISC indication

- CD-R(W) is blank/ not finalized
- Use a finalized CD-R(W)

INSERT DISC/CHECK DISC/DISC ERROR

indication

- No CD inserted
- Inserted a suitable disc
- CD badly scratched or dirty
- Replace/ clean CD, see Maintenance
- Laser lens steamed up
- Wait until lens has cleared

The CD skips tracks

- CD damaged or dirty
- Replace or clean CD
- shuffle or program is active
- Switch off shuffle / program

Sound skips during MP3 playback

- MP3 file made at compression level exceeding 320kbps
- Use a lower compression level to record CD tracks into MP3 format
- Disc damaged or dirty
- Replace or clean disc

Cannot find desired MP3 title

- Wrong file extension used and/ or file name with unsuitable text characters used
- Make sure the file names are typed in English text characters and that the MP3 files end with .mp3

**RENEWED
90 DAY
LIMITED WARRANTY**

9

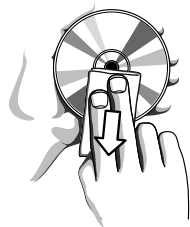
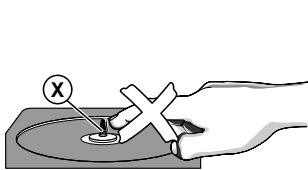
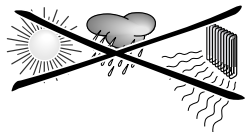

A

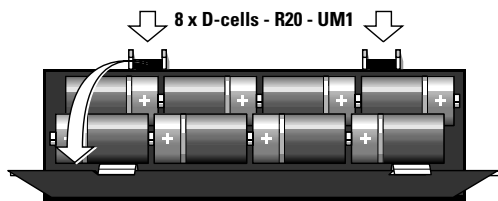

B

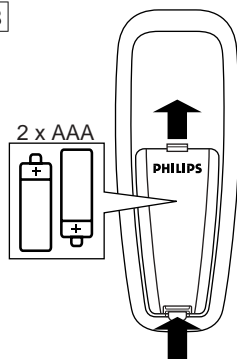

C

